

# Homework

- Chapter 11: #3-5

# **Infrared (IR) and Raman Spectroscopy**

## **红外和拉曼光谱法**

- **Infrared Spectroscopy**
  - **Introduction** 简介
  - **Instrumentation** 仪器
  - **Applications** 应用
- **Introduction of Raman Spectroscopy** 拉曼光谱简介

**Sir William Herschel: recognize Infrared, 1800**

**Abney & Festing: 1882-1900, Spectra vs organic group**

**W.W. Coblentz: 1908, Measured IR of several hundred molecules**

# A Few Things to Understand for Infrared

- Why do some molecules absorb infrared light and some not?
- What are the wavelength or better wavenumber (frequency)?
- How to measure absorption spectra in infrared region?

# IR Absorption Spectrum of a Thin Polystyrene Film 聚苯乙烯薄膜的红外吸收光谱

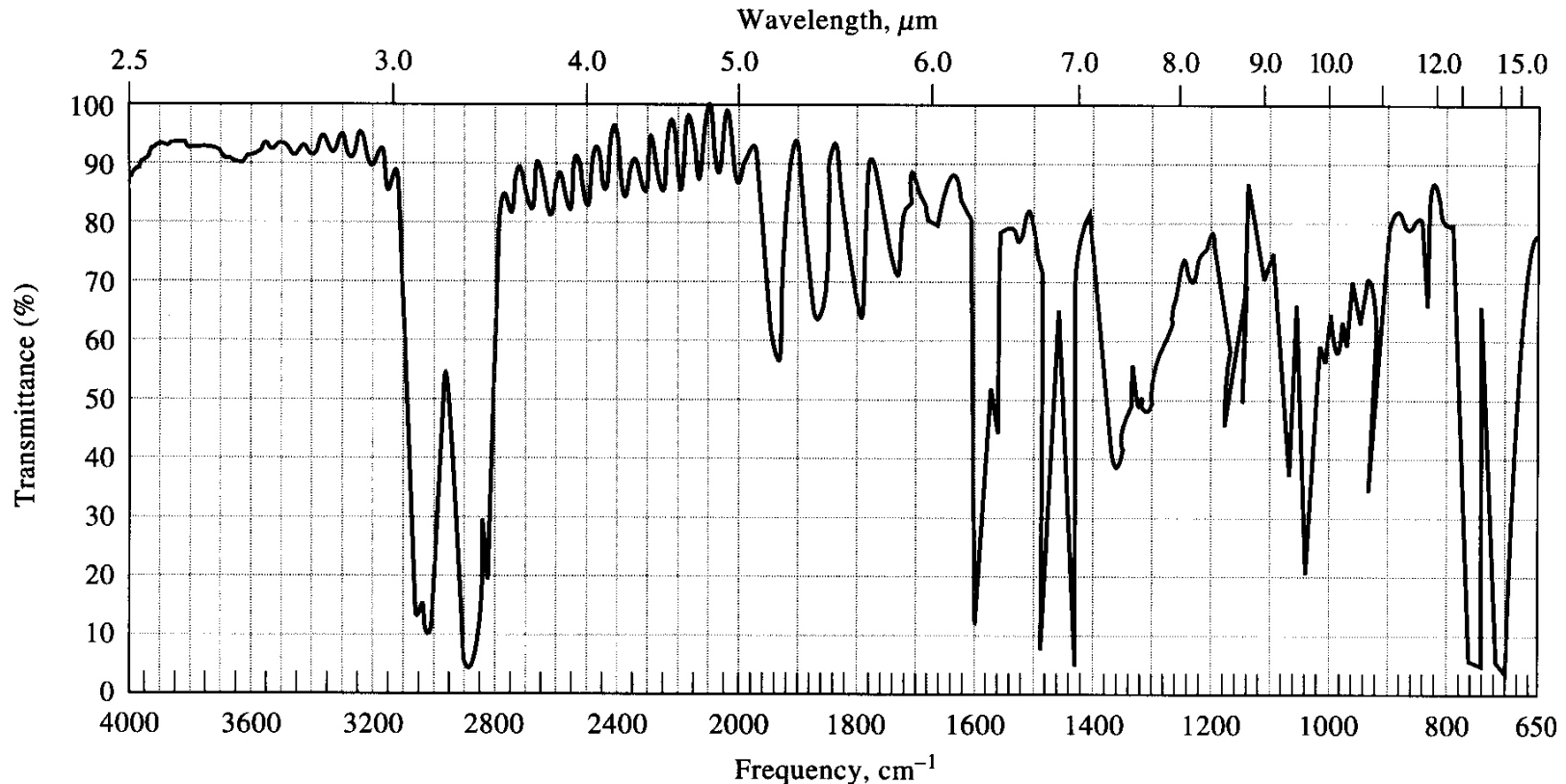

Note that the abscissa 横坐标 scale changes at  $2000 \text{ cm}^{-1}$ .

Usually wavenumber is used: directly proportional to energy.

横坐标使用波数表示，直接正比于振动能量。

# Molecular Dipole Moments 分子偶极矩

- Even though the total charge on a molecule is zero, the nature of chemical bonds is such that the positive and negative charges do not completely overlap in most molecules. Such molecules are said to be polar because they possess a permanent dipole moment.
- Examples:
  - With permanent dipole moment :  $\text{H}_2\text{O}$
  - With induced dipole moment:  $\text{N}_2$ ,  $\text{CO}_2$ ,  $\text{CCl}_4$

# Theory of Infrared (IR) Absorption

## 产生红外吸收的基本理论

- The alternating electrical field of the radiation interacts with fluctuations in the dipole moment 偶极矩 of the molecule. 激发光的电场向量波动与分子的偶极矩的涨落发生作用
- Absorption of IR is restricted to a net change in the dipole moment of the molecule associated with the vibrations or rotations  
只有能产生净偶极矩变化的分子振动和转动才能产生红外吸收, 如HCl
- If the frequency of the radiation matches the vibrational frequency of the molecule then radiation will be absorbed, causing a change in the amplitude of molecular vibration.  
当光的频率与分子振动频率匹配, 则分子吸收该频率的光, 振动幅度发生变化

**IR transparent molecules: He, Ne, H<sub>2</sub>, N<sub>2</sub>, O<sub>2</sub>**

# Types of Molecular Vibrations

## 分子振动类型

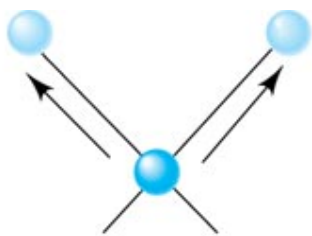

Symmetric

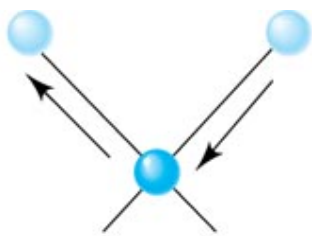

Asymmetric

### Stretching Vibrations

### 伸缩振动

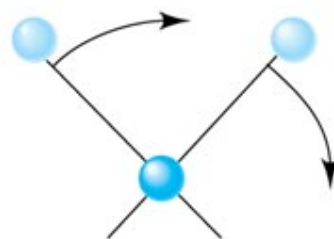

In-plane rocking

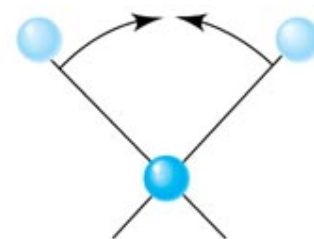

In-plane scissoring

“+” 面外弯折振动  
“-” 面内弯折振动

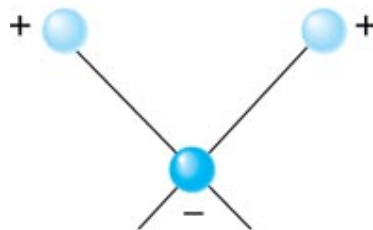

Out-of-plane wagging

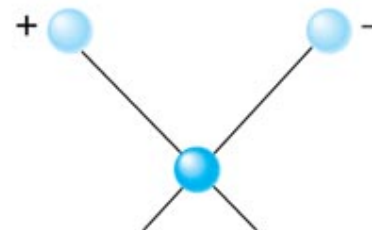

Out-of-plane twisting

### Bending Vibrations

### 弯曲振动

# Mechanic Model as a Stretching Vibration in a Diatomic Molecule

## 双原子分子伸缩振动的力学模型



**$k$ : force Constant** for the bond  
化学键的力常数

**Hooke's law**  
胡克定律

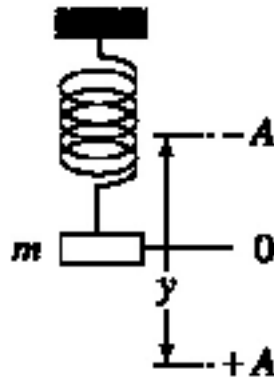

$$F = -ky$$



# Mechanic Model Approximation for the Stretching Vibration of a Diatomic Molecule 双原子分子伸缩振动的力学模型

$$\nu_m = \frac{1}{2\pi} \sqrt{\frac{k}{m}}$$

$\nu_m$  — natural frequency of the oscillator 基频

• Dependent on  $k$  of the spring and  $m$  of the attached body 基频与力常数和质量有关

力常数(N/cm): 两原子由平衡位置伸长单位长度时的恢复力。

How does the mass influence the vibration?

H<sub>2</sub>

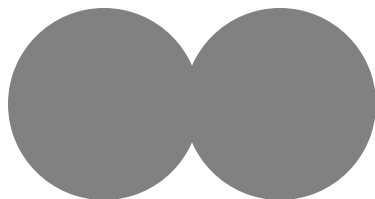

MM = 2 g/mole

I<sub>2</sub>

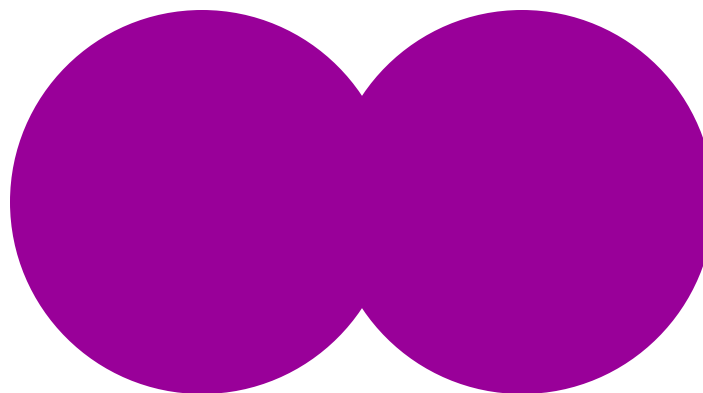

MM = 254 g/mole

The greater the mass - the lower the wavenumber

# Diatomic Molecule Stretch Vibration

## 双原子分子伸缩振动

对于含有两个不同质量的振动体系，使用折合质量( $\mu$ )

The mechanical model based equation may be modified to describe the behavior of the system consisting of two masses  $m_1$  and  $m_2$  connected by a spring by substitution of the **reduced mass**  $\mu$  for  $m$ .

$$\mu = \frac{m_1 m_2}{m_1 + m_2} \quad \text{thus, } \nu_m = \frac{1}{2\pi} \sqrt{\frac{k}{\mu}} = \frac{1}{2\pi} \sqrt{\frac{k(m_1 + m_2)}{m_1 m_2}}$$

In wavenumber expression 使用波数表达

$$\bar{\nu} = \frac{\nu}{c} = \frac{1}{2\pi c} \sqrt{\frac{k(m_1 + m_2)}{m_1 m_2}}$$

$$\bar{\nu} = \frac{\nu}{c} = \frac{1}{2\pi c} \sqrt{\frac{k(m_1 + m_2)}{m_1 m_2}}$$

- $\bar{\nu}$  — the wavenumber 波数为 absorbed light (**cm<sup>-1</sup>**)
- $c$  — the velocity 速度 of light (**cm · s<sup>-1</sup>**)
- $m_1$  &  $m_2$  — masses of the atoms 1 and 2 (**g**)  
 $m = A_r / N_A$  ( $A_r$  — atomic mass;  $N_A$  — Avogadro constant)
- $k$  — the force constant for the bond (**N · cm<sup>-1</sup>**)  
**(1 N = 1 kg · m/s<sup>2</sup>)**
  - Single bonds 单键: 5 N · cm<sup>-1</sup> (or 5 × 10<sup>2</sup> N · m<sup>-1</sup>)
  - Double bonds 双键: 10 N · cm<sup>-1</sup> (or 1 × 10<sup>3</sup> N · m<sup>-1</sup>)
  - Triple bonds 三键: 15 N · cm<sup>-1</sup> (or 1.5 × 10<sup>3</sup> N · m<sup>-1</sup>)

**Example** Calculate the approximate  $\bar{\nu}$  and  $\lambda$  of the fundamental absorption peak due to the stretching vibration of C=O

For the O atom:  $m_1 = 16 \text{ g} \cdot \text{mol}^{-1} / 6.022 \times 10^{23} \text{ mol}^{-1} = 2.7 \times 10^{-23} \text{ g}$

For the C atom:  $m_2 = 12 \text{ g} \cdot \text{mol}^{-1} / 6.022 \times 10^{23} \text{ mol}^{-1} = 2.0 \times 10^{-23} \text{ g}$

$\mu = (2.7 \times 10^{-23} \text{ g} \times 2.0 \times 10^{-23} \text{ g}) / (2.7 \times 10^{-23} \text{ g} + 2.0 \times 10^{-23} \text{ g}) = 1.1 \times 10^{-23} \text{ g}$

$$\begin{aligned} \nu &= \frac{1}{2 \times 3.14 \times 3.0 \times 10^{10} \text{ cm} \cdot \text{s}^{-1}} \sqrt{\frac{10 \text{ N} \cdot \text{cm}^{-1}}{1.1 \times 10^{-23} \text{ g}}} \\ &= \frac{1}{1.88 \times 10^{11} \text{ cm} \cdot \text{s}^{-1}} \sqrt{\frac{10 \times 1000 \text{ g} \times 100 \text{ cm} \cdot \text{s}^{-2} \cdot \text{cm}^{-1}}{1.1 \times 10^{-23} \text{ g}}} \\ &\approx 1600 \text{ cm}^{-1} \end{aligned}$$

The carbonyl stretching band is found experimentally to be in  $1600\text{-}1800 \text{ cm}^{-1}$

# Quantum Treatment of Vibrations

$$E = \left(\nu + \frac{1}{2}\right)h\nu_m \quad \nu \text{ the vibrational quantum number}$$

Selection Rules:  $\Delta\nu = \pm 1$

---

## Anharmonicity:

The selection rule is not rigorously followed

Overtones are sometimes observed

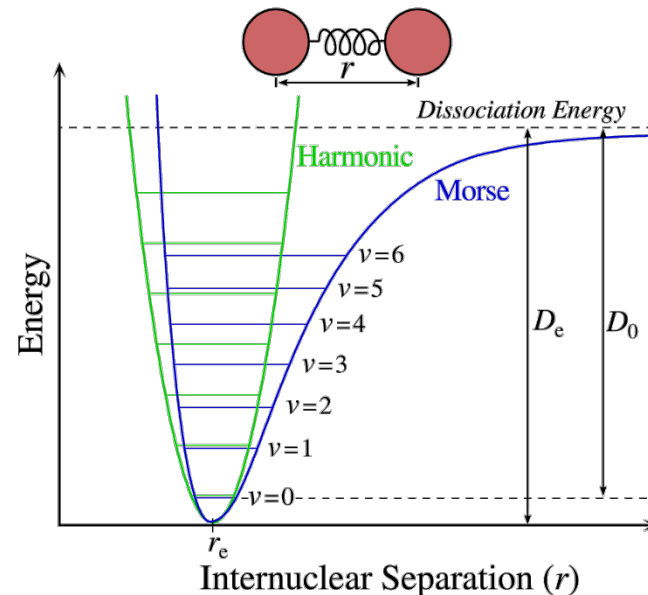

# IR Spectra of chloroform and deuteriochloroform

## 氯仿与氘代氯仿的红外光谱

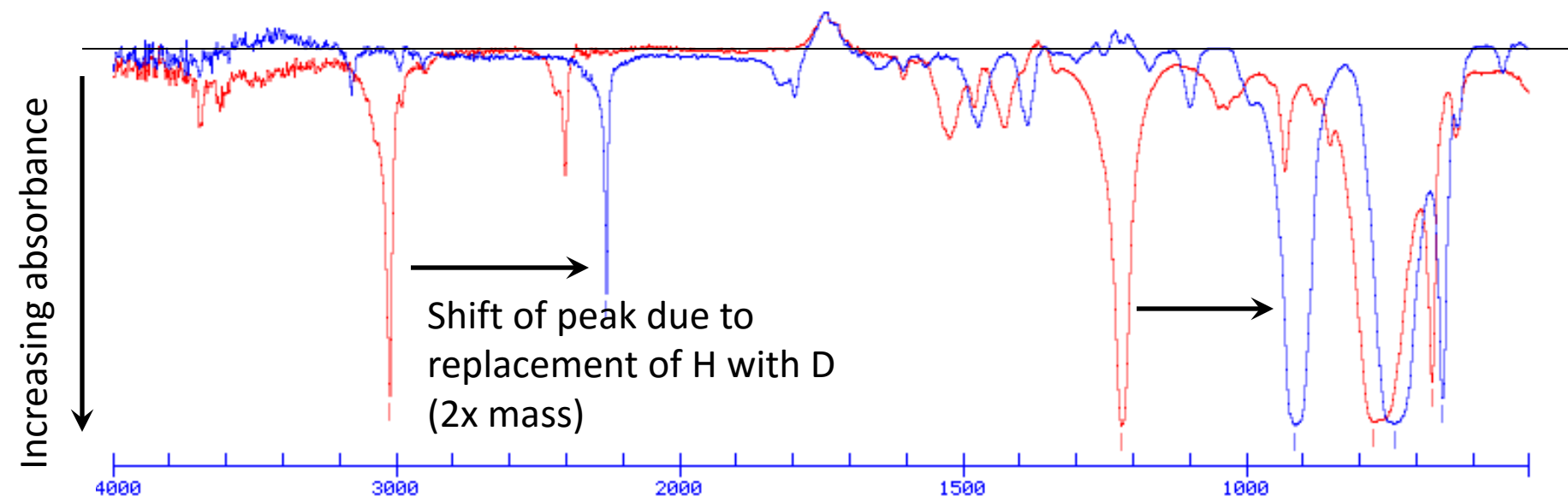

Mode of vibration	$\text{CHCl}_3$ Calculated*	$\text{CHCl}_3$ Measured	$\text{CDCl}_3$ Measured
C-H stretching	3002	3020	2256
C-H bending	1120	1219	912
C-Cl stretching	701	773	737
C-Cl bending	418	671	652

\* Spartan '02 AM1 minimization

# Basic Functional Groups 基本官能团的振动频率

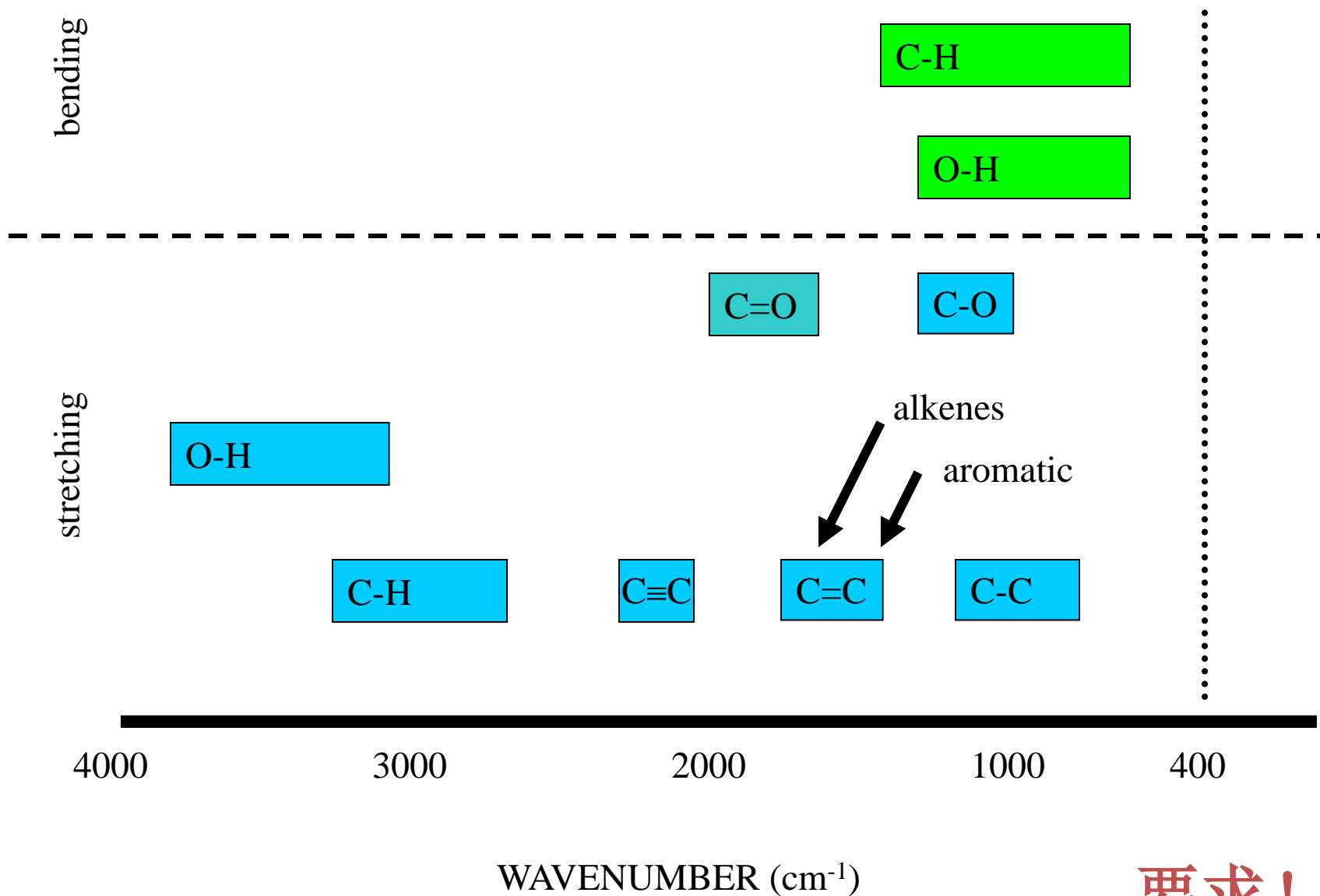

要求!



# Announcement

- Homework: chapter 11 6-7
- Final Exam: 7月1日 上午 理教410
- 答疑时间:
  - 6月29-30日 8:30-11:30 AM, 2:00-4:00 PM
  - 其他时间答疑请邮件预约

# Vibrations in a Polyatomic Molecule

## 多原子分子的振动

- A molecule containing  $N$  atoms has  $3N$  degrees of freedom in motion 含有 $N$ 原子的分子有 $3N$ 自由度
- Each of the vibrations is called **a normal mode** 简正振动
  - $3N-6$ : 含有 $N$ 原子的分子有 $3N-6$ 个简正振动自由度
  - Linear Molecule 线形分子:  $3N-5$

# Instrumentation for IR Measurement

## 用于红外范围测量的仪器

- **Dispersive Infrared Spectrometers** 色散型红外光谱仪  
The same as UV-vis spectrophotometer with the light source, the dispersive elements and the detector adequately designed for IR  
**Drawbacks: 缺点**  
**Slow scan speed, low sensitivity and low resolution**  
扫速慢 灵敏度低 光谱分辨率低
- **Fourier-Transform Infrared Spectrometers**  
傅里叶变换红外光谱仪  
The interference of radiation between two beams to yield an interferogram  
两束光经过干涉产生干涉谱

# Dispersive Type 色散型

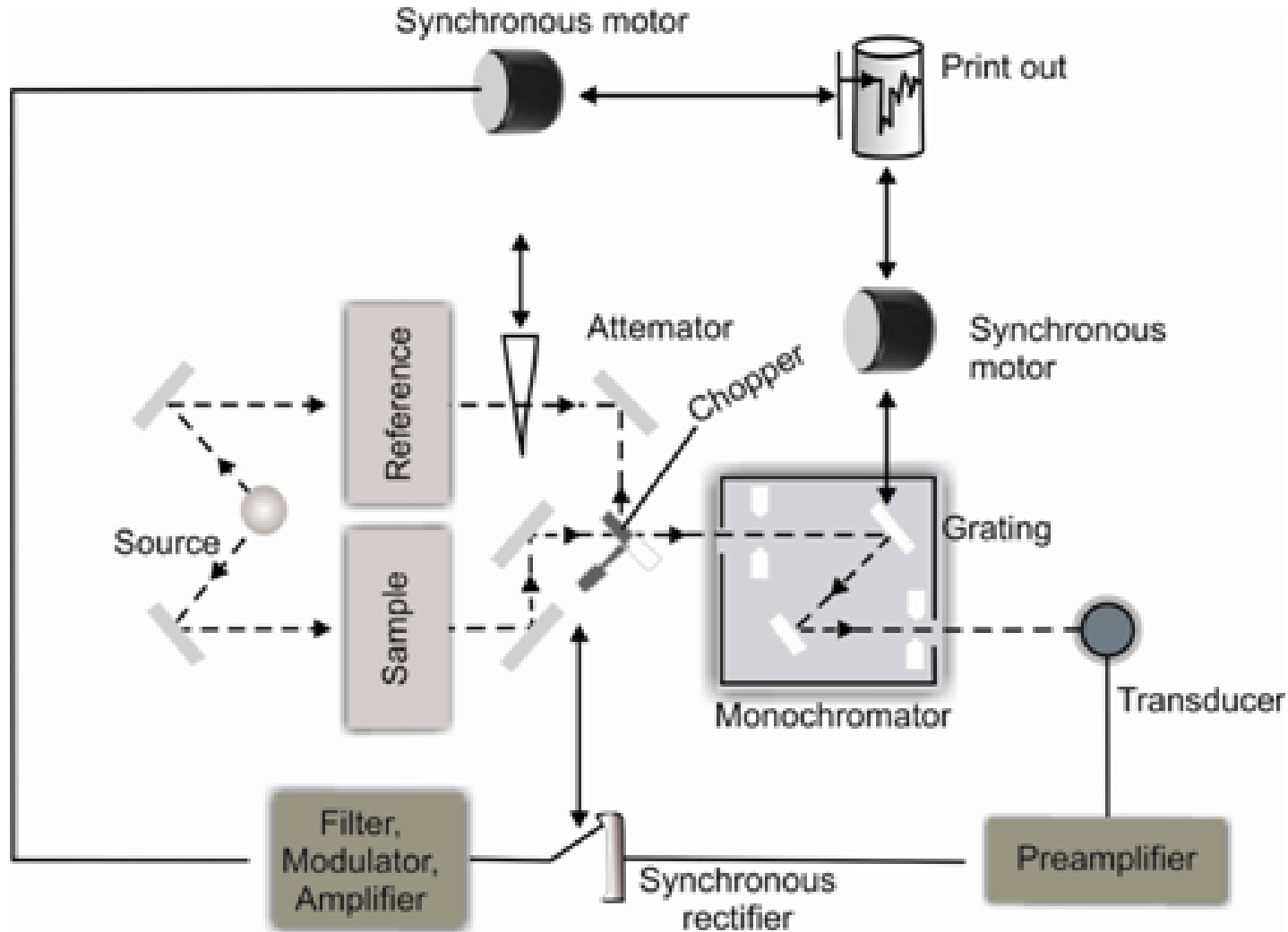

1. Dual beam; 2. Location of sample cell

# IR Sources 红外光源

- **Need Strong radiation power, for mid-IR**
  - By materials根据材质分类
    - Silicon carbide rod (硅碳棒) (glow bar)
    - Rare earth oxide ceramic piece (稀土氧化物陶瓷片) (Nernst filament/Nernst glower)
  - By ways of cooling根据冷却方式分类
    - Water cooled source (Globar), e.g. Silicon carbide rod (硅碳棒)
    - Air cooled source, e.g. Nichrome wire 镍铬电热丝 or a small ceramic piece (Air & water)
- CO<sub>2</sub> laser
- Hg arc (Far IR), Tungsten filament (Near IR)

# Infrared Transducers 红外检测器

Type	$\lambda$ , nm
Photon Detectors 光子检测器	
Phototubes 光电管	150-1000
Photomultiplier Tubes 光电倍增管	150-1000
Silicon photodiodes 硅光二极管	350-1000
Photoconductive cells 光敏电阻器	1000-50000
Thermal Detector 热检测器	
Thermocouples 热电偶	600-20000
Bolometers 辐射热测定器	600-20000
Pneumatic cells 气动元件	600-40000
Pyroelectric cells 热释电检测器	1000-20000

# Optical Path Difference and Interferograms

## 光程差与干涉谱

### Illustration of Optical Path Difference

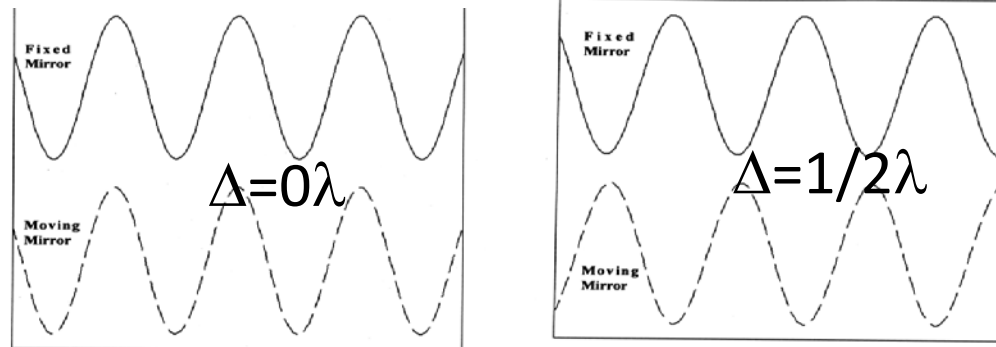

### Interferograms

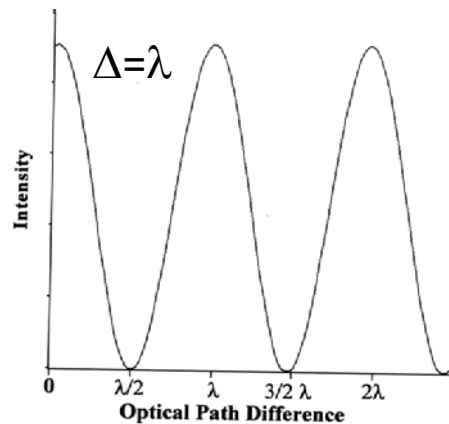

Monochromatic

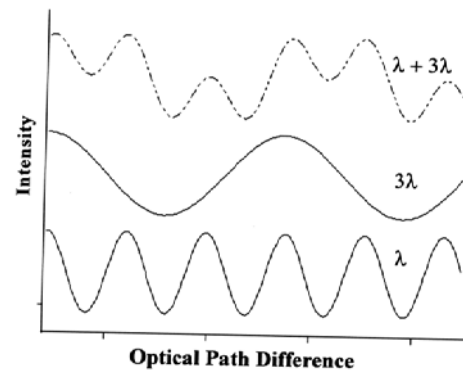

The sum of two wavelength

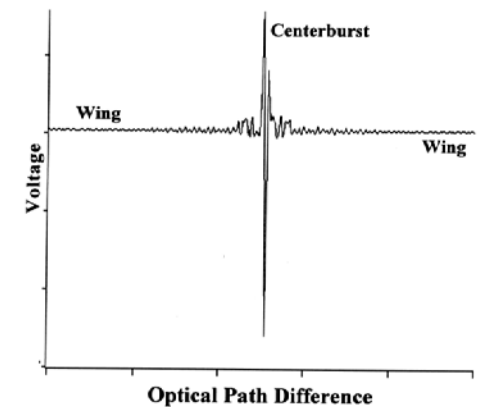

Broadband IR source

# Interferogram & IR Spectrum of $\text{CH}_2\text{Cl}_2$

## $\text{CH}_2\text{Cl}_2$ 的干涉谱和红外谱

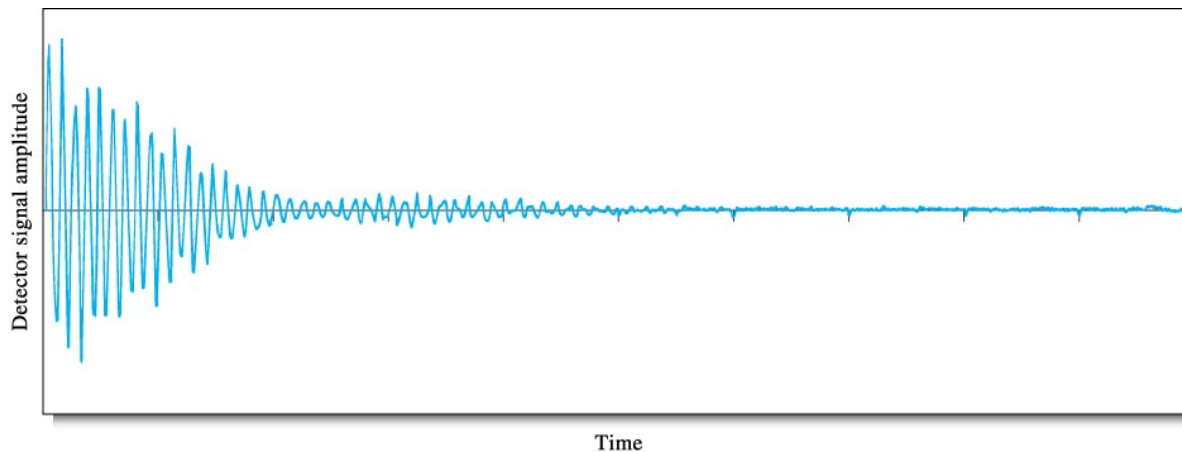

(a)

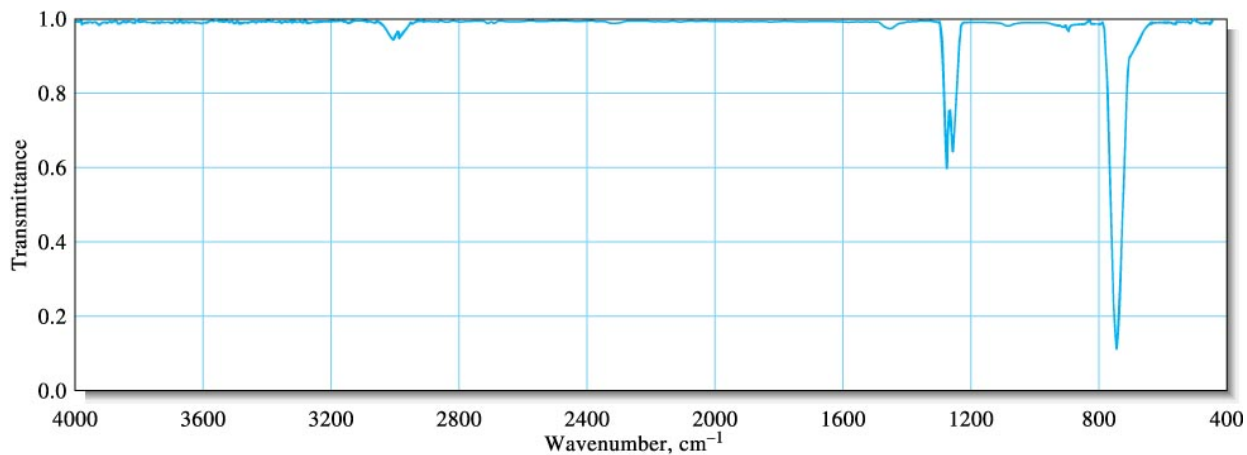

(b)



# Michelson Interferometer 迈克尔逊干涉仪

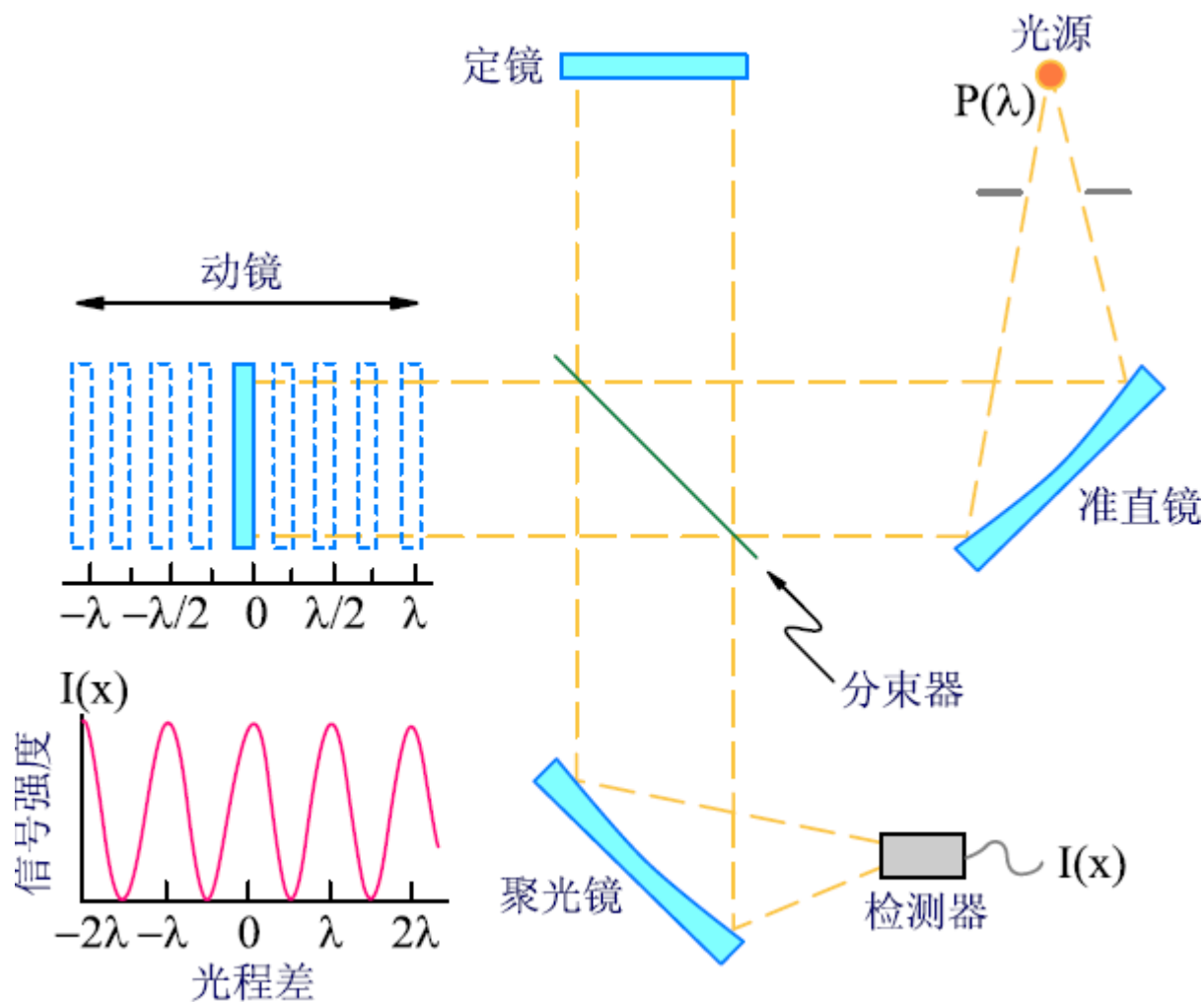

# Michelson Interferometer 迈克尔逊干涉仪

- ✧ **Beam splitter** 光束分裂器
- ✧ **Stationary mirror** 固定镜
- ✧ **Moving mirror at constant velocity** 可动镜
- ✧ **Motor driven Micrometer screw** 马达驱动的微米螺杆
- ✧ **He/Ne laser** 氦氖激光器: **sampling interval, control mirror velocity**

# Fourier Transform Infrared Spectrometers

## FTIR 傅里叶变换红外光谱仪

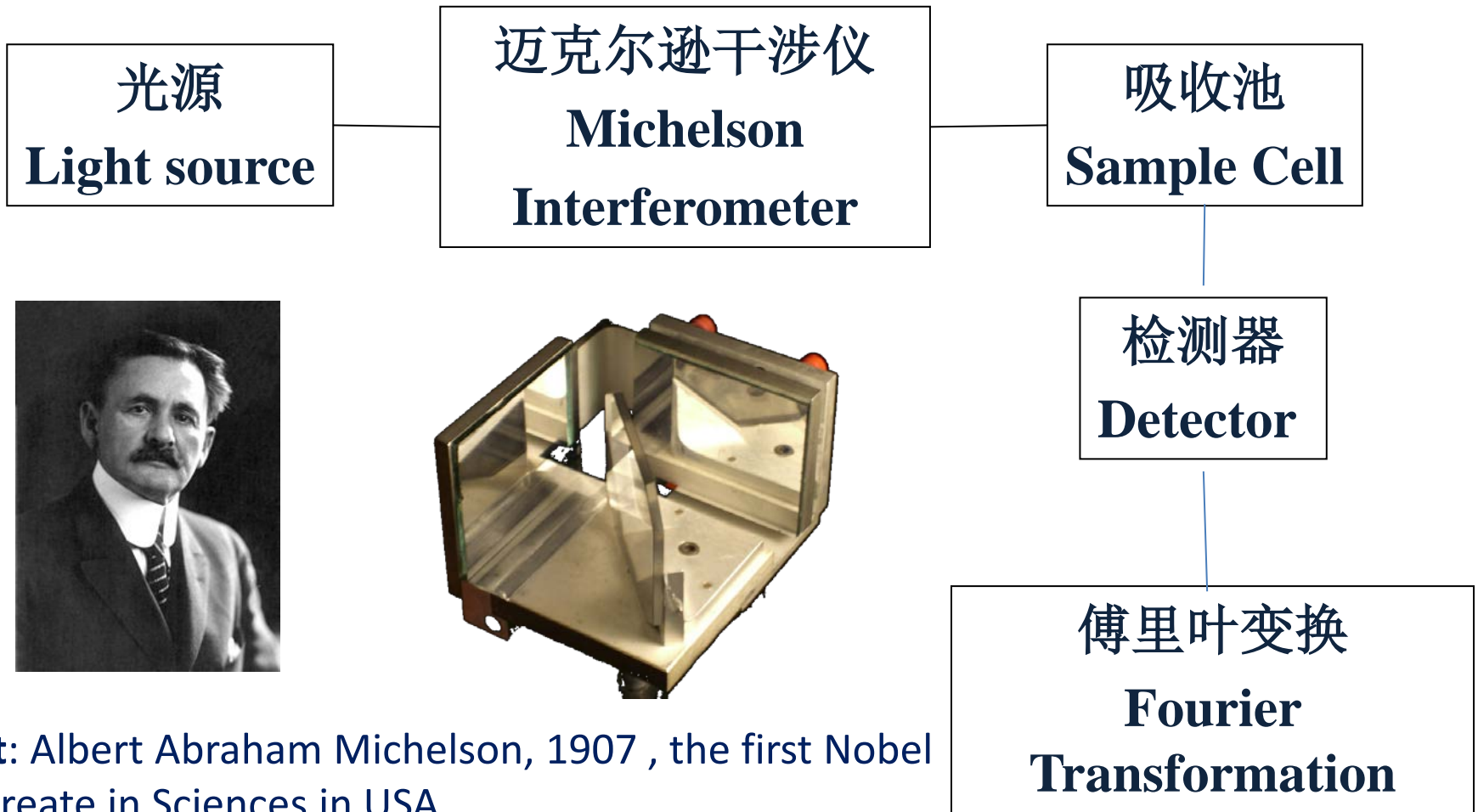

**Left:** Albert Abraham Michelson, 1907 , the first Nobel Laureate in Sciences in USA

**Right:** A Michelson Interferometer on a optical table  
<http://en.wikipedia.org>

# FTIR Spectrophotometer

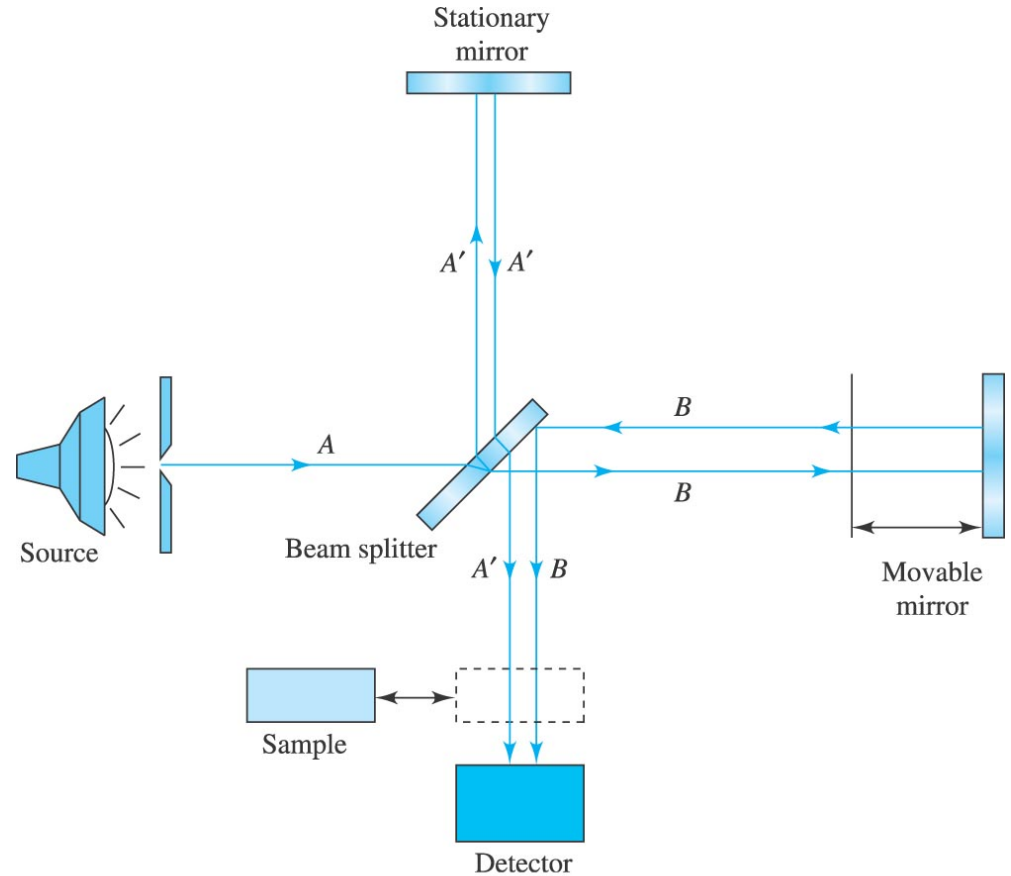
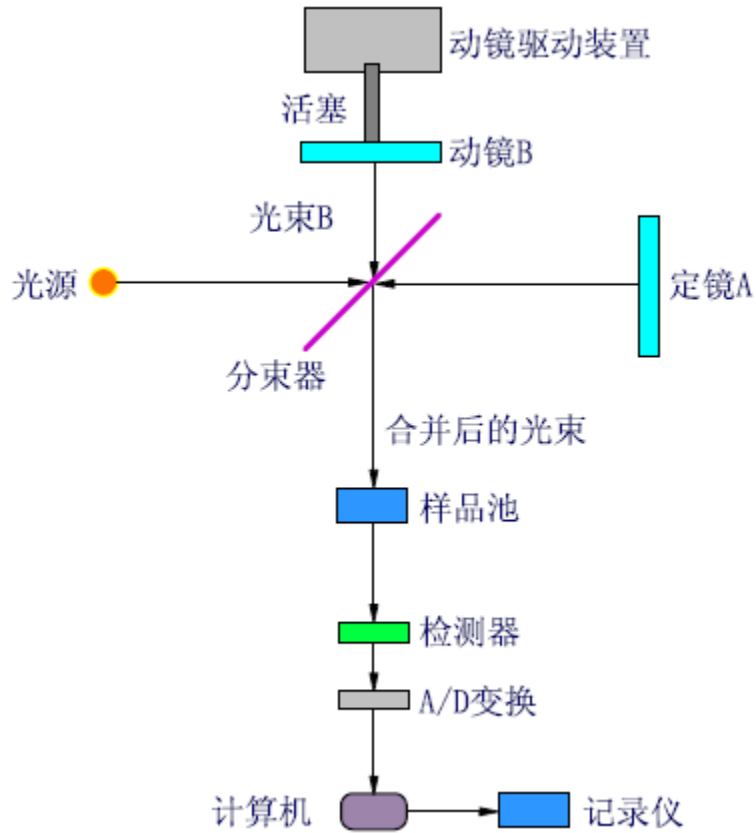

# Fourier Transform vs Dispersion IR Spectrometer



# The Advantages & Disadvantages of FTIR

## FTIR的优缺点

- **The throughput (Jacquinot) advantage**

No slit restriction, energy throughput is high, thus improved SNRs.

**High sensitivity!**

- **High resolving power and wavelength reproducibility**

- **The multiplex (or Fellgett) advantage**

All source wavelengths are measured simultaneously in an interferometer. **High sensitivity and speed!**

- **The Connes advantage:**

**Precision** of peak position is high with He-Ne laser as a reference for mirror movement.

- **Monobeam – artifacts like H<sub>2</sub>O or CO<sub>2</sub> peaks**

# Application of FTIR

- **Quantitative** – Molecular structure, functional group
  - The Sadtler Standard Spectra series
  - Aldrich FT-IR Libraries
  - Sigma Bio-Chemicals FT-IR Library
- **Quantitative**
  - Lambert-Beer's Law

# Sample Preparation 样品制备

- **Sample forms: Gas, liquid and solid**  
样品形态：气、液、固
- **Sample contains no free water**  
样品中不含水
- **It is desirable that the transmittance is within 10%-80%**  
最好透光率在10%-80%之间



# Schematic of a Typical Infrared Gas Cell

## 红外气体池

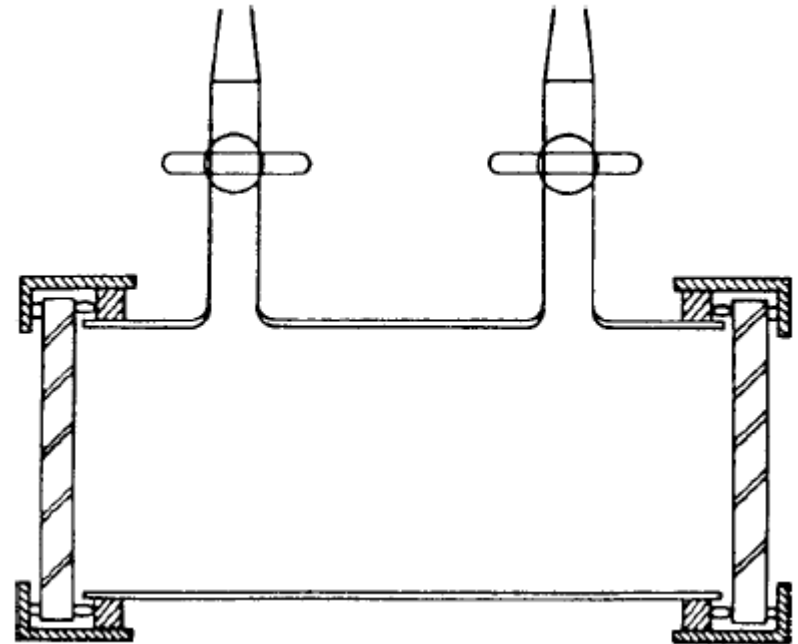
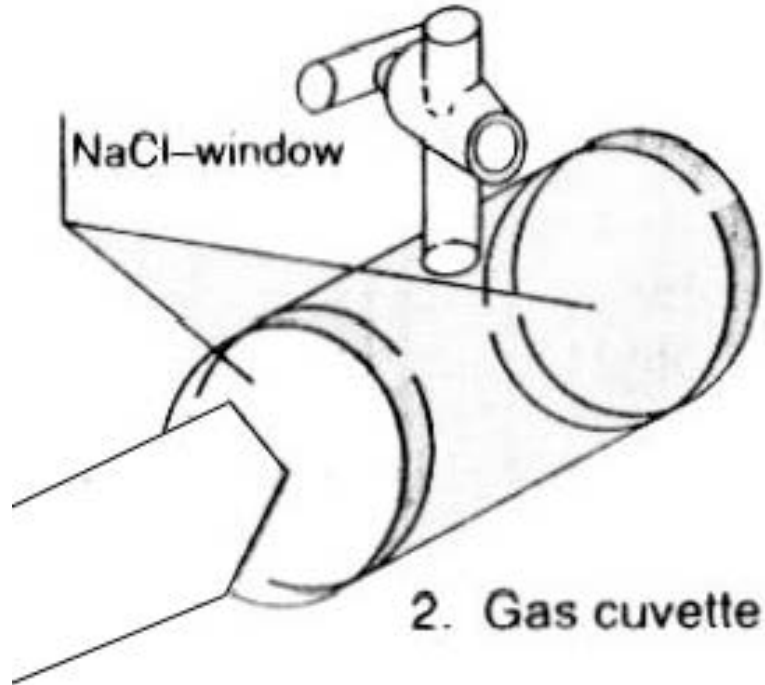

# Liquid Cell液池

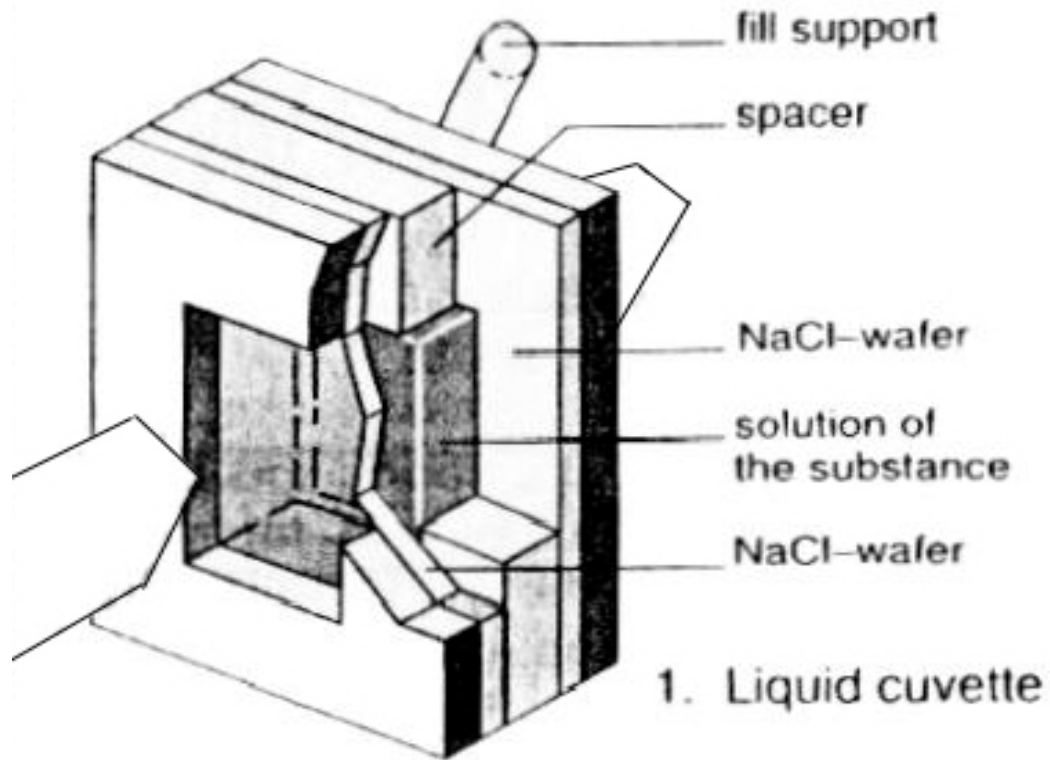

# Liquid Sample Film Preparation

## 液体样品膜制备



# Solid Sample Preparation 固体样品制备

- KBr Pellet (KBr压片法)

KBr as a support and a diluent(稀释剂)、agate mortar(玛瑙研钵)

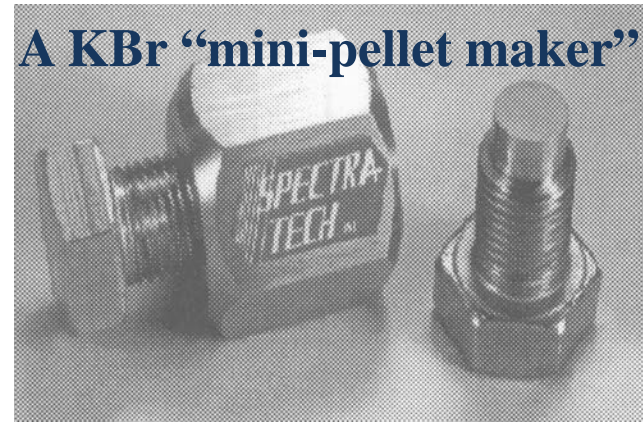

- Mull Sample(石蜡糊法):

Nujol as Mulling agent, agate mortar

- Cast films成膜法

for polymer

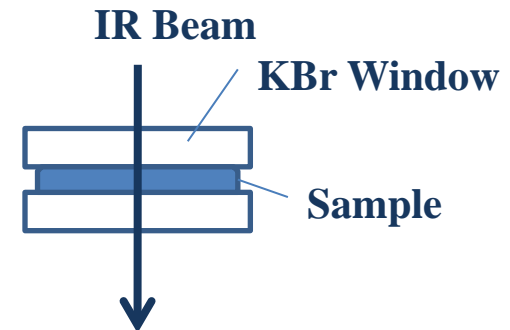
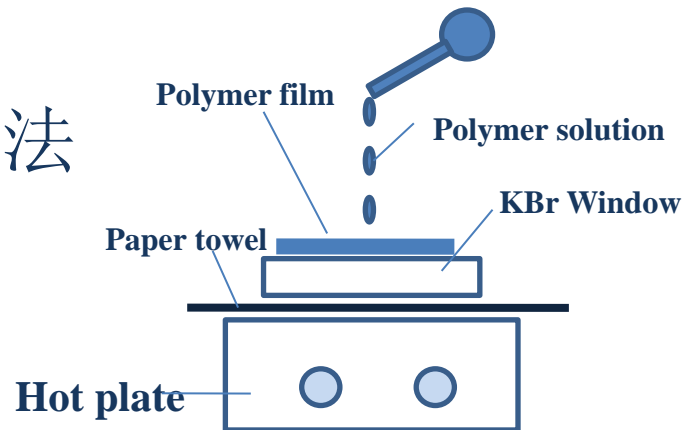

A diagram of how to cast a polymer film    A diagram of a mull sample



# Raman Spectroscopy, A Brief History

- **1923** Theoretical prediction by the Austrian physicist A. Smekal  
“The quantum theory of dispersion” (Naturwissenschaften 11, p. 873, 1923)
- **1928** Experimental discovery
  - by the Indians C.V. Raman and K.S. Krishnan in Kalkutta  
“The optical analog of the Compton effect” (Nature 121, p.711, 1928)
  - by the Russians G. Landsberg et L. Mandelstam à Moscou  
“A novel effect of light scattering in crystals” (Naturwissenschaften 16, p.557, 1928)
- **1930** Nobel Prize: Sir C.V. Raman (\* 1888, +1970)  
“... for his work on light scattering and the discovery of the later called Raman effect ...”

# Introduction to Raman Spectroscopy

## 拉曼光谱简介

- Raman spectroscopy:
  - A spectroscopic technique based on inelastic scattering of monochromatic light. 物质对单色光的非弹性散射
  - The sample is irradiated with a laser source of visible or near infrared **monochromatic** radiation.  
以单色激光激发样品
  - Stokes and anti-Stokes scattering are measured in infrared region  
在红外波长范围测量Stokes和anti-Stokes 散射

# Schematic Illustration for Raman Measurement

## 拉曼光谱测定示意图

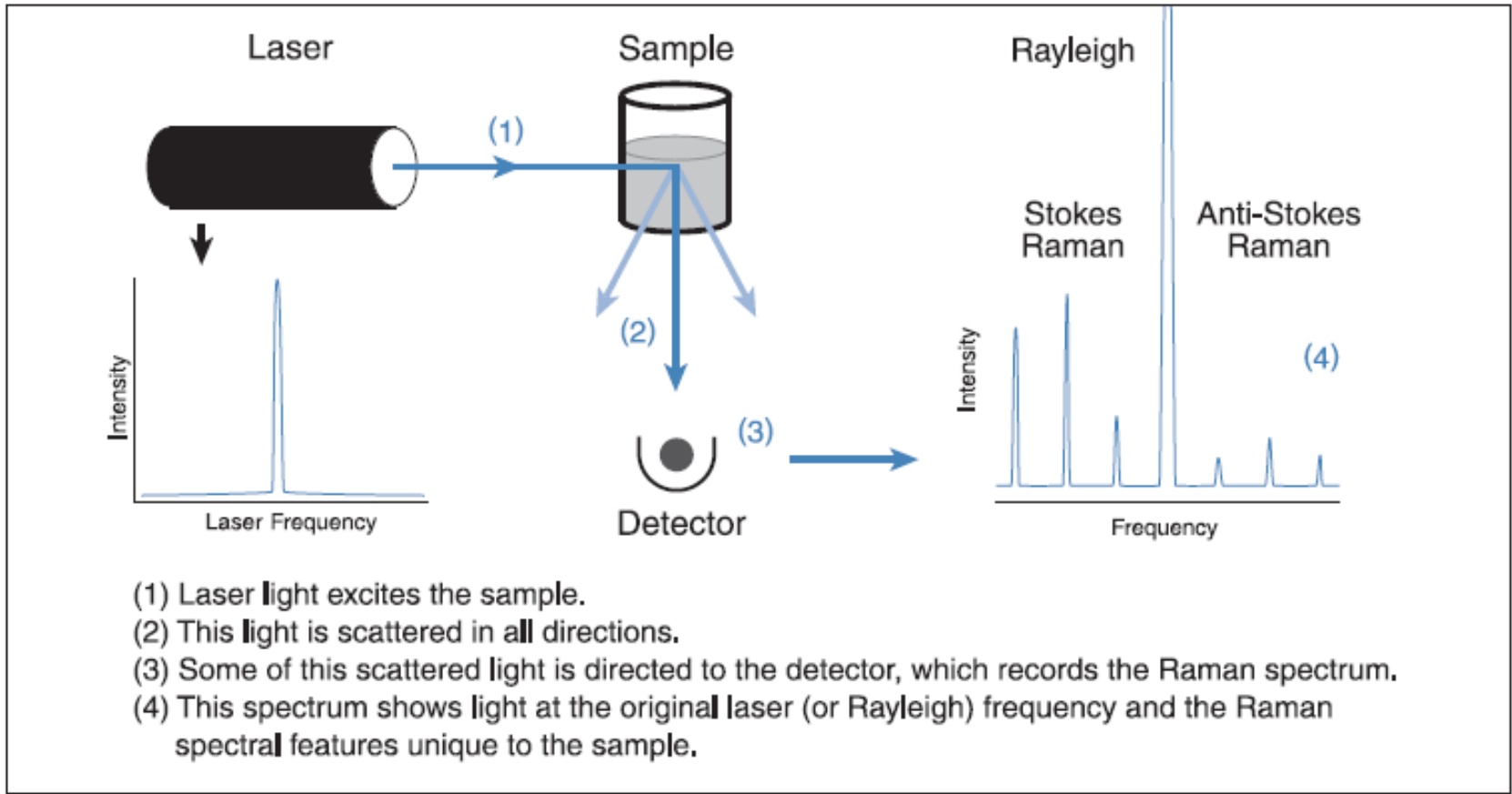

# Main Optical Transitions: Absorption, Scattering, & Fluorescence

## 分子主要跃迁：吸收、散射以及荧光

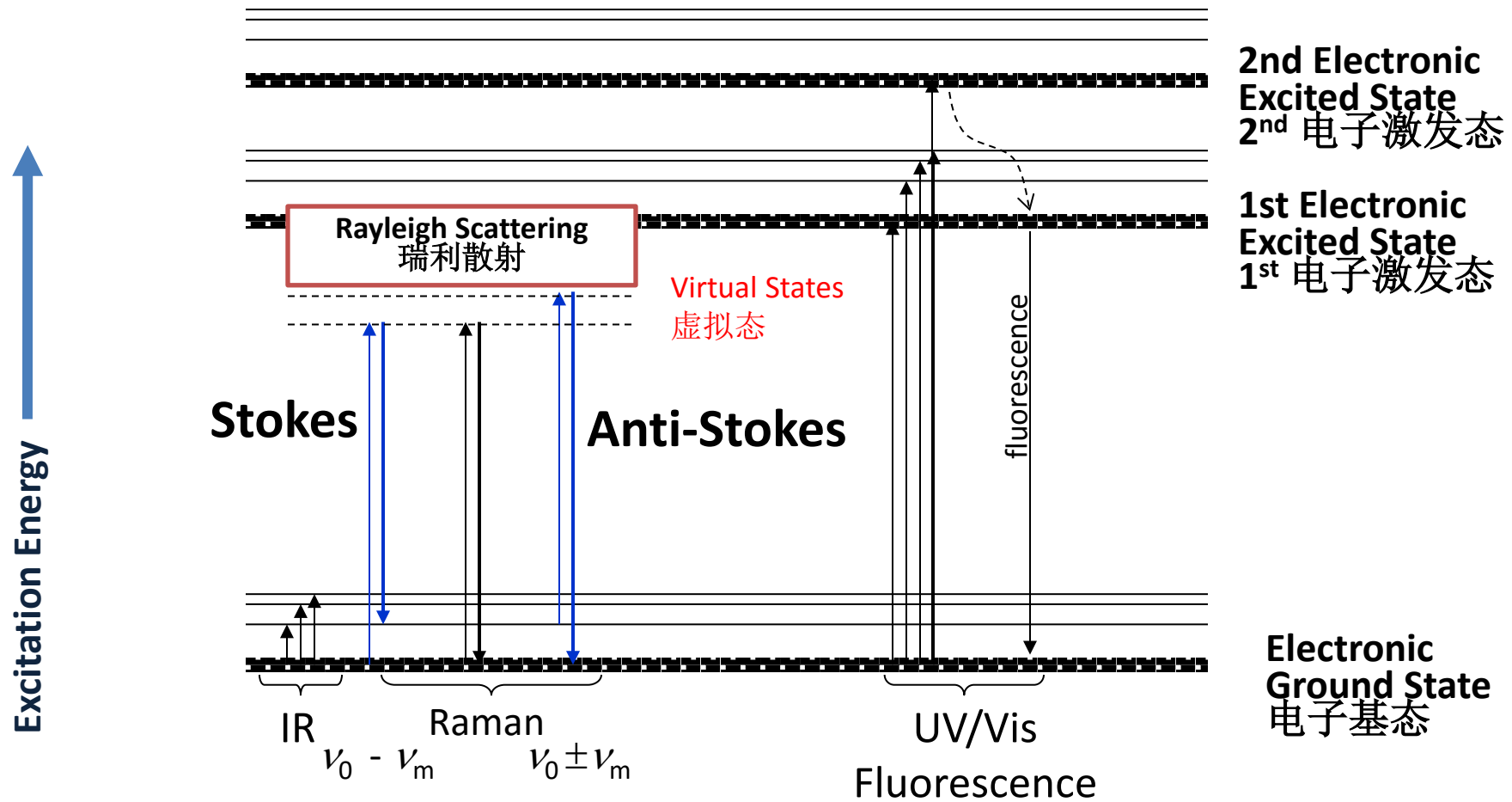

*The virtual state* — a short-lived distortion of the electron distribution by the electric field of the incident light.



# Classical Explanation 经典的电磁理论解释

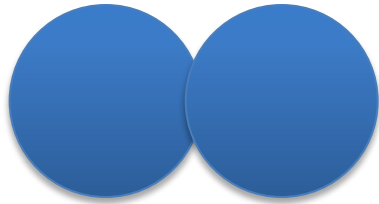

$$\bar{\nu} = \frac{\nu}{c} = \frac{1}{2\pi c} \sqrt{\frac{k(m_1 + m_2)}{m_1 m_2}}$$

$$P = \alpha \cdot E \quad E = E_0 \cos 2\pi \nu_{\text{ex}} t, \quad \alpha = \alpha_0 + \left( \frac{\partial \alpha}{\partial r} \right) (r - r_{\text{eq}})$$

$$r - r_{\text{eq}} = r_m \cos 2\pi \nu_v t$$

$P$  – induced dipole 诱导偶极矩

$\alpha$  – the polarizability 极化率

A measure of the deformability of the bond in an electric field

$\alpha_0$  – the polarizability of the bond at the equilibrium internuclear distance  $r_{\text{eq}}$

$r$  – the internuclear separation at any instant.

# Classical Explanation 经典的电磁理论解释

$$P = \alpha_0 E_0 \cos 2\pi \nu_{\text{ex}} t +$$

$$E_0 r_m \left( \frac{\partial \alpha}{\partial r} \right) \times \cos(2\pi \nu_{\text{v}} t) \cos(2\pi \nu_{\text{ex}} t)$$

$$P = \alpha_0 E_0 \cos 2\pi \nu_{\text{ex}} t +$$

$$\frac{1}{2} E_0 r \left( \frac{\partial \alpha}{\partial r} \right) \times [\cos 2\pi t (\nu_{\text{ex}} + \nu_{\text{v}}) + \cos 2\pi t (\nu_{\text{ex}} - \nu_{\text{v}})]$$

# Basics for Raman Spectroscopy

- Frequency 频率：
  - Rayleigh Scattering 瑞利散射: Emitting light with the same frequency as an excitation source  $\nu_0$   
散射光频率与激发光频率相等
  - Stokes Frequency (Stokes 频率): Emitting light with  $\nu_0 - \nu_m$   
发出光子的频率小了  $\nu_m$
  - Anti-stokes Frequency (反Stokes 频率): Emitting light with  $\nu_0 + \nu_m$   
发出光子的频率大了  $\nu_m$
- Intensity 强度：
  - Rayleigh Scattering : 99.999% ; Raman Scattering: 0.001%
  - Stokes Intensity  $\gg$  Anti-Stokes Intensity
- Other Characteristics 其他特点
  - Independent of the excitation wavelength 与激发波长无关
  - Associated with vibration & rotation energy 对应振动和转动能量

# Raman Spectrum of Room-Temperature Chloroform ( $\text{CHCl}_3$ ) Obtained with 514.5 nm Light

以514.5 nm光源获得的氯仿的室温拉曼谱

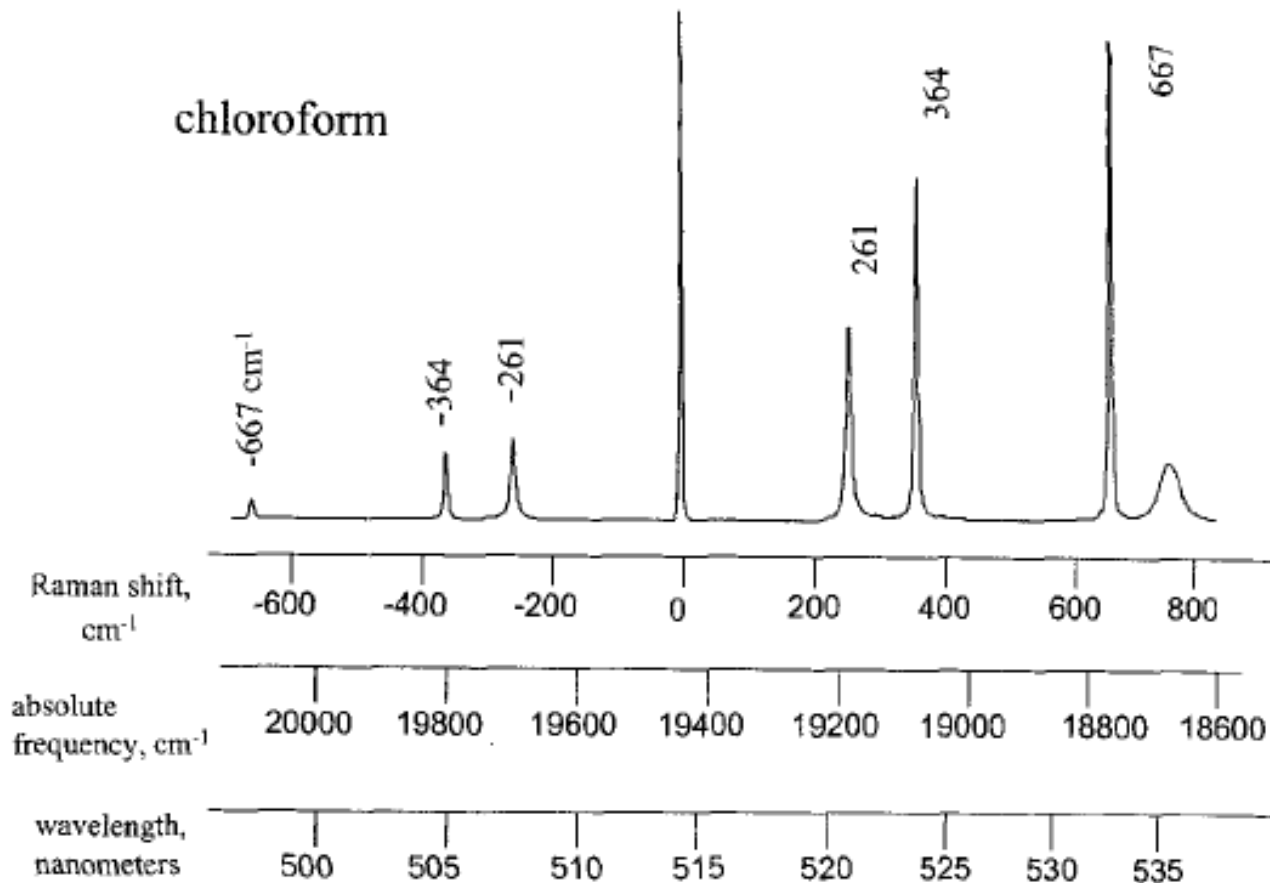

# Comparing IR & Raman

- **Vibrational & Rotational Energy: Same energy/frequency region**
- **Mechanism difference**产生光谱的机理
  - **IR: dipole moment change**偶极矩变化
  - **Raman: momentary distortion of the electrons distributed around a bond in a molecule, then back to normal state by emission**

分子诱导偶极矩的变化，即分子的电子壳层形变，正负电荷中心相对位移，形成诱导偶极矩

$$\mu = \alpha \cdot E$$
- **N<sub>2</sub>, Cl<sub>2</sub>, & H<sub>2</sub> IR transparent**
  - **Polarizability of the bond: maximum at maximum distance; minimum at minimum distance**

# Comparing Raman and Infrared Spectra

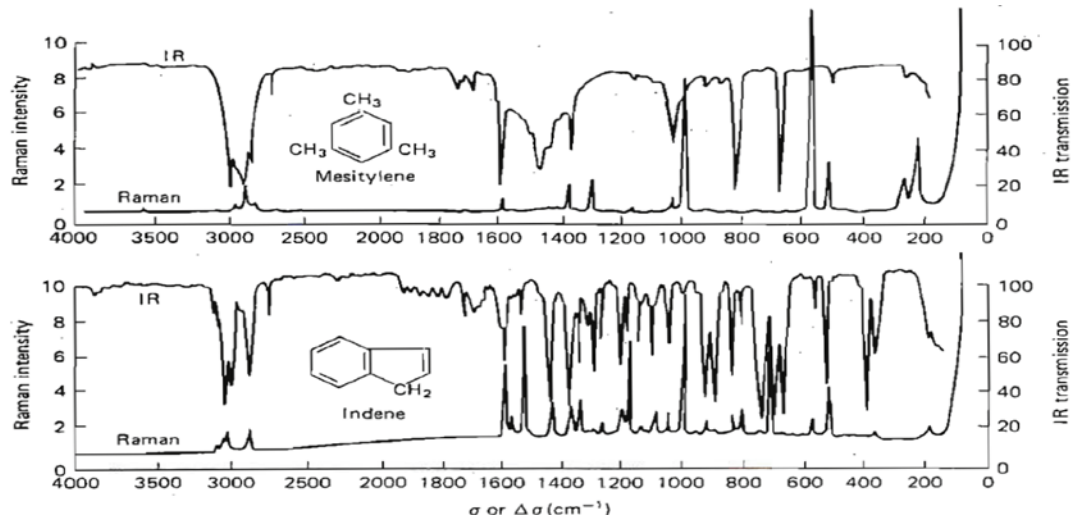

- **IR inactive & Raman active** 一些振动具有红外和拉曼活性
- **IR inactive or Raman active –Complementary**  
Each associated with a different set of vibrational modes in a molecule  
一些振动具有红外或者拉曼活性，互为互补，对应于不同的振动模式

# Comparing IR & Raman

**CO<sub>2</sub>**

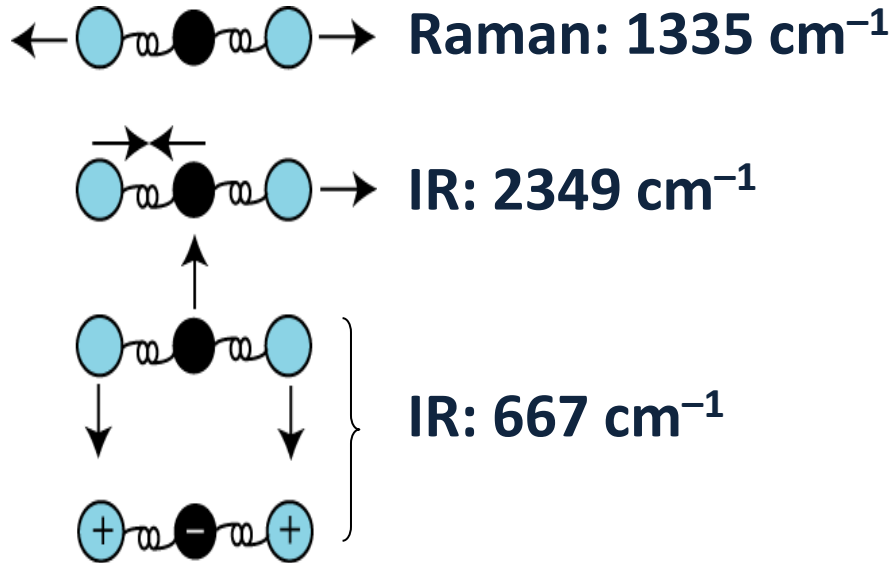

**H<sub>2</sub>O**

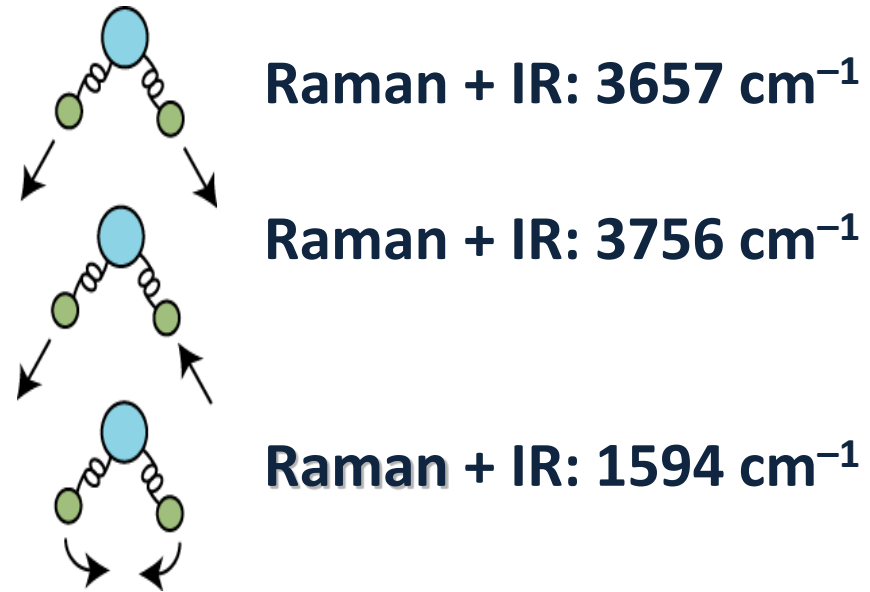

# Raman Spectroscopy vs. Infrared Absorption

## Advantages & Disadvantages

- Water does not cause interference  
水的拉曼峰弱，不干扰测定
- Glass or quartz cells can be used  
可以用玻璃或石英池
- Need laser 需要激光
- Interference by fluorescence from the sample or impurity in the sample 样品中的荧光物质干扰测定



# Instrumentation for Raman Spectroscopy

## 拉曼光谱仪

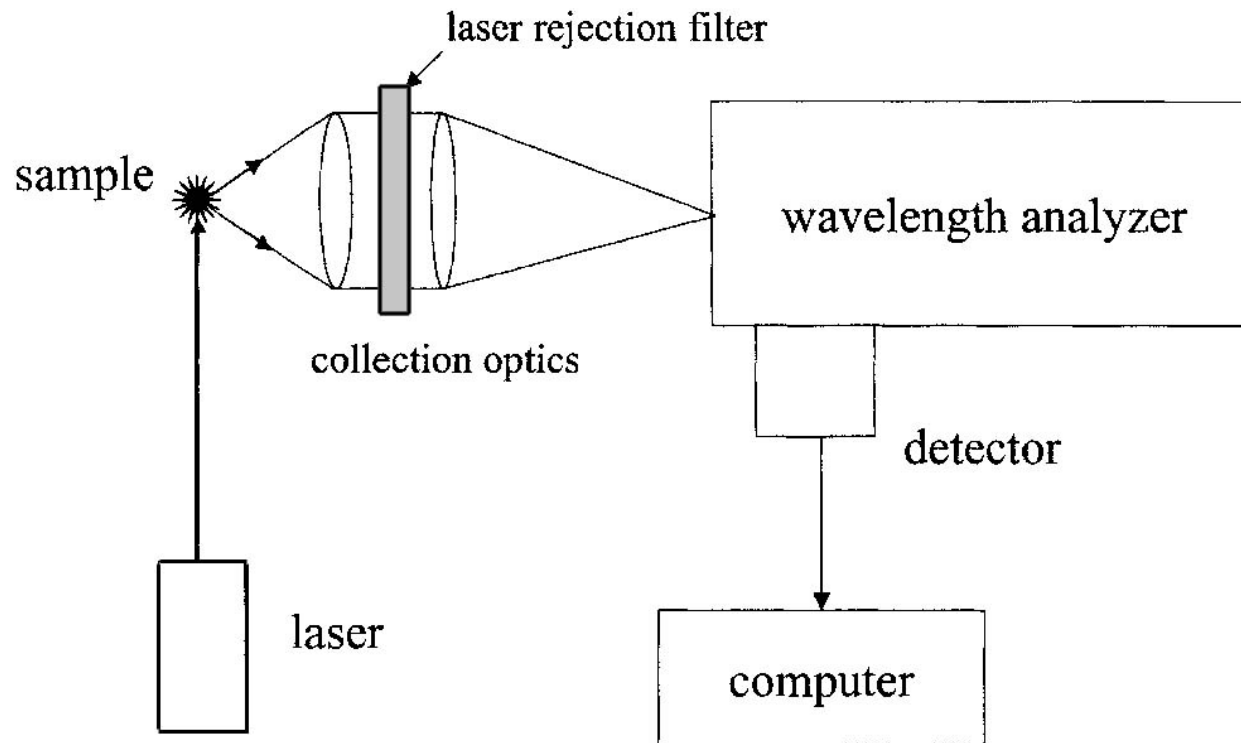

# Summary of Molecular Spectroscopy

## 分子光谱小结

- ***E* field of electromagnetic irradiation interacts with molecule electronic, vibrational, rotational transitions, and other low frequency transition**

电磁波的电场向量与分子的电子、振动、转动与其他低频跃迁的相互作用产生分子的吸收光谱。当吸收的能量以光的形式释放出来，产生荧光、磷光以及拉曼散射

- **Application in Analytical Chemistry**
  - **Light absorption – UV-vis (to NIR), IR spectrometry**
  - **Light emission – fluorescence, Raman scattering**

# Main Optical Transitions: Absorption, Scattering, & Fluorescence

## 分子主要跃迁: 吸收、散射以及荧光

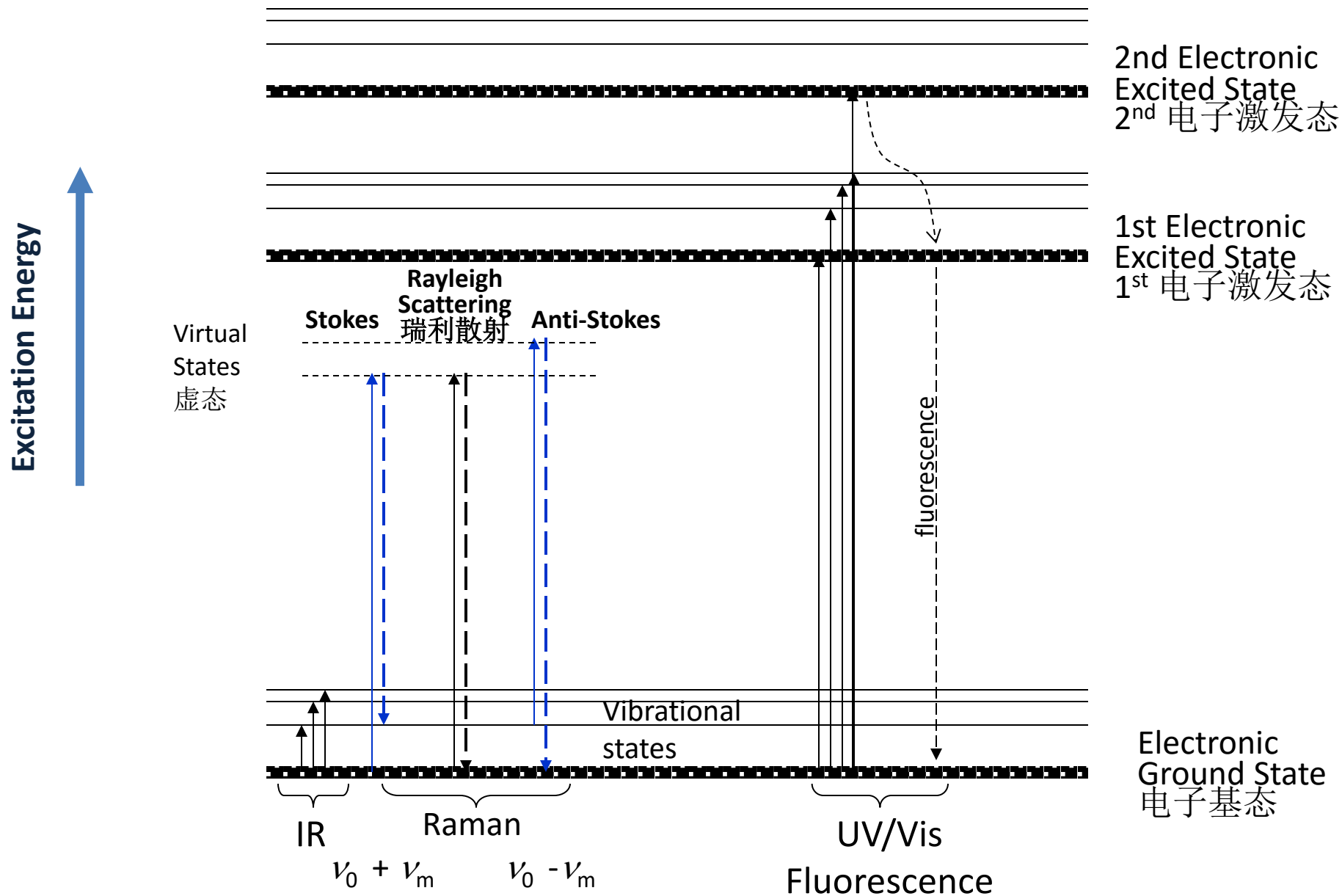

# Instrumentations for UV/Vis absorption & Fluorescence

## 紫外/可见吸收与荧光仪器构造

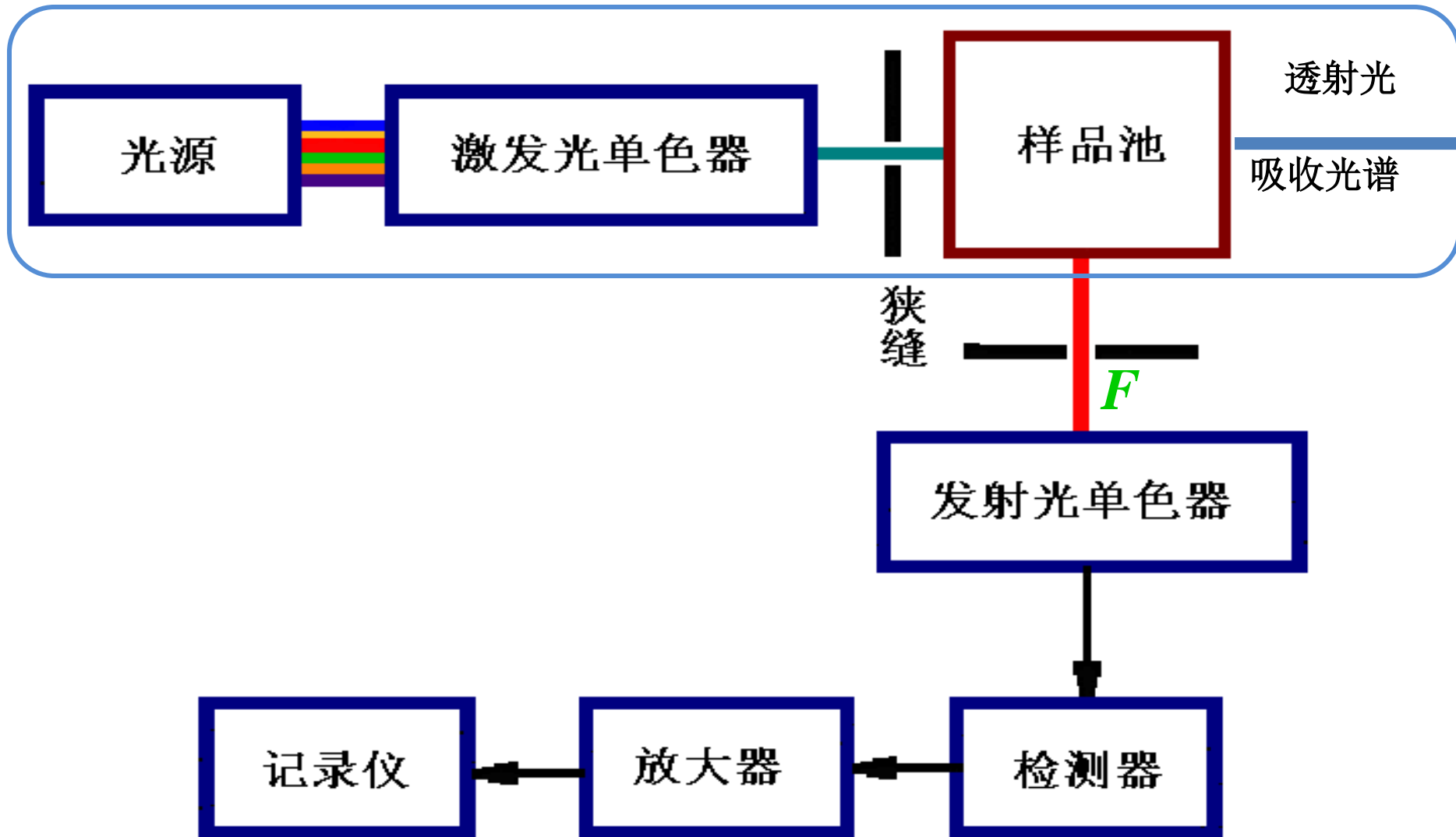

# Instrumentations for Infrared Absorption

## 红外吸收检测器

### 色散型



### FTIR



# Build A Spectrophotometer

Methods	Light Source	Monochromator	Sample Cell	Detector
UV-Visible	Tungsten for visible D <sub>2</sub> for UV	One after light source	Glass for visible Quartz for UV	PMT
Fluorescence	Xenon arc	One after light source One after sample cell	Quartz	PMT, CCD
Infrared	Silicon carbide rod (硅碳棒) Rare earth oxide ceramic piece (稀土 氧化物陶瓷片)	One after sample cell for dispersive type Michelson Interferometer for FTIR	Halide salt	Thermocouples 热电偶 Pyroelectric cells 热释电 检测器 MCT (碲镉汞检测器) (又称光电导检测器)
Raman	Monochromatic laser	One after sample cell	Optical glass or quartz	PMT

# Sensitivity 灵敏度

- Fluorescence vs. UV-visible absorption  
荧光分析法灵敏度高于紫外-可见分光光度法
  - Emitting light in a dark background  
荧光光谱法从黑背景检测光子
  - Source and detection can be adjusted to 仪器可以调整
    - PMT
    - Source
  - $I_f = 2.3 \phi \epsilon b c I_0$ 
    - Molecular structural modification 改造分子结构以提高量子产率,  $\phi$
    - Solution parameters 改变溶液条件提高量子产率,  $\phi$

# 分子光谱的要求

- 定量原理
- 定性原理
- 仪器原理、框图、各部分元件名称以及材质要求
- 计算：
  - 波长与频率的换算
  - 基于Beer's Law 定量
  - 红外光谱中: 振动基频计算
  - Raman中: Raman位移波数 $\rightarrow$ 波长的计算